



# HOSPIniaga



KNOW IT LOVE IT



# CSSD

Katalog Produk



# Teknologi Pesawat Tempur



**STERA 120 & 60**  
Plasma Sterilizer





\*Foto unit Stera 120

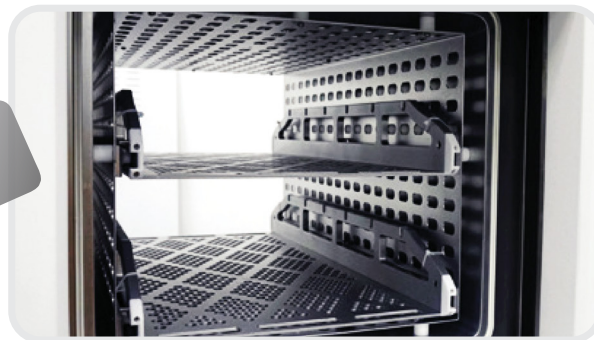

### Kuat dan tahan

Kapasitas besar dengan material pesawat tempur, tahan tekanan tinggi dan anti korosi untuk performa yang baik



**Cassette H<sub>2</sub>O<sub>2</sub>**  
Purifikasi H<sub>2</sub>O<sub>2</sub> diatas 95%



**Pedal Kaki Elektrik**  
Kemudahan akses buka dan tutup pintu dalam sterilisasi alat

### Fitur lainnya:

- Berbagai pilihan mode sterilisasi (*Short, Long, Endo & Drying*)
- Menggunakan konsentrat H<sub>2</sub>O<sub>2</sub> yang aman untuk pengoperasian
- Purifikasi sistem H<sub>2</sub>O<sub>2</sub> 58% ke 95%
- Teknologi *Soft Heating* yang mampu mendistribusikan suhu saat sterilisasi
- Kebisingan <55 dB
- Akses perbaikan mudah



#### Stera 120

TKDN  
40,98%

- Kapasitas 120 L
- 10" LCD layar sentuh
- 58% konsentrasi kaset H<sub>2</sub>O<sub>2</sub> didesain dengan teknologi *anti-evaporation*
- *Double doors*

**Rp 1.300.000.000,-**



#### Stera 60

TKDN  
41,12%

- Kapasitas 60 L
- 10" LCD layar sentuh
- 58% konsentrasi kaset H<sub>2</sub>O<sub>2</sub> didesain dengan teknologi *anti-evaporation*

**Rp 970.000.000,-**



# Hemat Daya & Biaya



**STERACLAV**  
Steam Sterilizer



# Teknologi MinoTect

Inovasi Teknologi dalam menghemat Energi, Air dan Waktu untuk sterilisasi yang lebih Efisien.



**40 menit** waktu pensterilan, dengan konsumsi daya listrik yang rendah



Konsumsi air hanya **50 liter** per siklus

# Program Sterilisasi



**Tekstil 134°C**

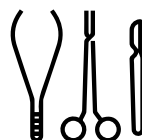

**Instrumen Bedah 134°C**



**Rubber 121°C**

## Jenis Test

### Helix Test

Memeriksa kemampuan dalam mensterilkan benda berongga

### Bowie Dick Test

Mengevaluasi kinerja alat dengan memastikan pembuangan udara yang efektif

### Vacuum Test

Menguji kemampuan vakum sebelum alat digunakan

## Solusi Perawatan Praktis

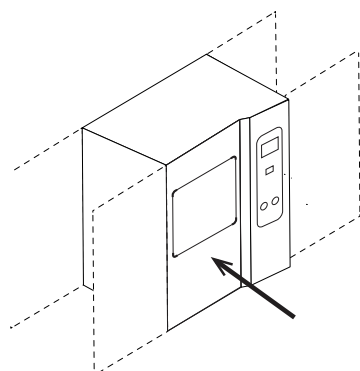

Semua komponen dapat diservis dari sisi depan (sisi non-steril)

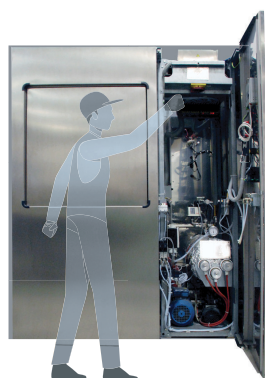

Bukaan depan satu panel

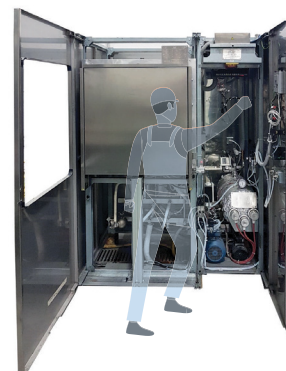

Bukaan kedua panel depan



**Steraclav 300**

**Rp 1.885.000.000,-**



**Steraclav 500**

**Rp 2.050.000.000,-**



**Steraclav 800**

**Rp 2.587.500.000,-**



## HOSPITAL LAUNDRY MACHINE HIGH SPIN

**AIRA**  <sup>®</sup>

**Aira Series**

### Keamanan dan Efisiensi Terbaik

Medical Grade Laundry Rumah Sakit dengan Teknologi Canggih untuk Penghematan Energi, Air dan Biaya Produksi.

**TKDN  
27,95%**

**AIRA**  <sup>®</sup>

### Aira 55 & 85

- Kapasitas 55 kg / 85 kg
- LCD layar sentuh
- Suhu pencucian mencapai 90°C
- Termasuk *dosing pump*
- Program dapat dikonfigurasi
- Penginstalan yang mudah
- *Single door*

Aira 55

**Rp 1.012.000.000,-**

Aira 85

**Rp 1.303.500.000,-**



## HOSPITAL LAUNDRY MACHINE HIGH SPIN



### Aira 23

- Kapasitas 23 kg
- LCD layar sentuh
- Suhu pencucian mencapai 90°C
- Termasuk *dosing pump*
- Program dapat dikonfigurasi
- Penginstallan yang mudah
- *Single door*

**Rp 495.000.000,-**



**TKDN  
27,95%**

## HOSPITAL LAUNDRY MACHINE BARRIER



### Linex 55

- Kapasitas 55 kg
- LCD layar sentuh
- Suhu pencucian mencapai 90°C
- Termasuk *dosing pump*
- Program dapat dikonfigurasi
- Penginstallan yang mudah
- *Double doors*

**Rp 1.750.000.000,-**



**TKDN  
26,69%**

## HOSPITAL LAUNDRY MACHINE BARRIER



### Linex 30

- Kapasitas 30 kg
- LCD layar sentuh
- Suhu pencucian mencapai 90°C
- Termasuk *dosing pump*
- Program dapat dikonfigurasi
- Penginstallan yang mudah
- *Double doors*

**Rp 1.033.000.000,-**



**TKDN  
26,69%**

## DRYING SYSTEM

**AIRA** ■ ■ ■<sup>®</sup>

### ES 55

- Kapasitas 55 kg
- LCD layar sentuh
- Program dapat dikonfigurasi
- Peningstallan yang mudah

**Rp 445.000.000,-**



**TKDN  
25,21%**

## DRYING SYSTEM

**AIRA** ■ ■ ■<sup>®</sup>

### ES 34

- Kapasitas 34 kg
- LCD layar sentuh
- Program dapat dikonfigurasi
- Peningstallan yang mudah

**Rp 220.000.000,-**



**TKDN  
25,21%**

## IRONING SYSTEM

**AIRA** ■ ■ ■<sup>®</sup>

### FI 2000/33

- Lebar roll 2 meter
- Diameter roll 33 cm
- LCD layar sentuh
- Program dapat dikonfigurasi
- Peningstallan yang mudah

**Rp 252.000.000,-**



**TKDN  
25,53%**



## Bekubox XC Series

Blood Bank Refrigerator

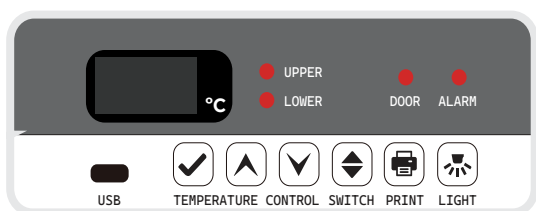

### *Pengaturan suhu yang cerdas*

Dilengkapi dengan mikrokomputer presisi tinggi pada pengaturan suhu yang mampu menjaga pengaturan suhu tetap stabil dan terdapat kompresor berkualitas tinggi sehingga meningkatkan efisiensi sistem dan kerja pendinginan. *Backup battery* mencegah suhu agar tidak drop ketika listrik padam.





### Sistem Keamanan

Alarm suara dan alarm visual serta kunci pintu sebagai pelindungan maksimal



### Auto Defrost

Pencairan bunga es otomatis untuk memastikan keakuratan suhu di dalam kabinet



### Penyimpanan Data

Tersedia USB port yang digunakan untuk penyimpanan data untuk jangka waktu 12 bulan terakhir.



### Desain rak yang fleksibel

Dilengkapi dengan rak-rak berkualitas tinggi yang bisa diatur ketinggiannya.

## HOSPITAL REFRIGERATOR



TKDN  
43,48%

**AIRA** 

### Bekubox XC-618L

- 2 to 6 °C *bloodbank refrigerator*
- Kapasitas 630 liter
- *Precise temperature control display*
- Bukan pintu depan
- Dapat menampung hingga 312 kantung darah (450ml)

**Rp 173.500.000,-**



**AIRA** 

### Bekubox XC-268L

- 2 to 6 °C *bloodbank refrigerator*
- Kapasitas 268 liter
- *Precise temperature control display*
- Bukan pintu depan
- Dapat menampung hingga 220 kantung darah (450ml)

**Rp 117.000.000,-**

## HOSPITAL REFRIGERATOR

**TKDN**  
28,01%



**AIRA** ■ ■ ■<sup>®</sup>

### Bekubox YC-1505

- 2 to 8 °C medical refrigerator
- Kapasitas 1505 liter
- Precise temperature control display
- Bukanan pintu depan

**Rp 208.000.000,-**

**TKDN**  
29,03%

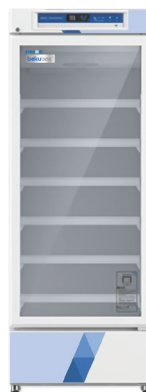

**AIRA** ■ ■ ■<sup>®</sup>

### Bekubox YC-525

- 2 to 8 °C medical refrigerator
- Kapasitas 525 liter
- Precise temperature control display
- Bukanan pintu depan

**Rp 105.500.000,-**

## HOSPITAL REFRIGERATOR

**TKDN**  
30,38%



**AIRA** ■ ■ ■<sup>®</sup>

### Bekubox YC-1015

- 2 to 8 °C medical refrigerator
- Kapasitas 1015 liter
- Precise temperature control display
- Bukanan pintu depan

**Rp 142.000.000,-**

**TKDN**  
31,72%



**AIRA** ■ ■ ■<sup>®</sup>

### Bekubox YC-75

- 2 to 8 °C medical refrigerator
- Kapasitas 75 liter
- Precise temperature control display
- Bukanan pintu depan

**Rp 41.500.000,-**

## HOSPITAL REFRIGERATOR

**TKDN**  
26,27%



**AIRA** ■ ■ ■<sup>®</sup>

### Bekubox YC-275 E

- 2 to 8°C medical refrigerator
- Kapasitas 275 liter
- Precise temperature control display
- Bukanan pintu atas

**Rp 82.021.000,-**

**TKDN**  
35,17%



**AIRA** ■ ■ ■<sup>®</sup>

### Bekubox YC-150 E

- 2 to 8 °C medical refrigerator
- Kapasitas 150 liter
- Precise temperature control display
- Bukanan pintu atas

**Rp 65.000.000,-**



DIPRODUKSI OLEH PT. HOSPI NIAGA UTAMA

Jl. Pasir Panjang No. 124, Cilampeni, Kec. Katapang  
Kab. Bandung 40921, Jawa Barat - Indonesia

[www.hospiniaga.com](http://www.hospiniaga.com) 022-20508887

